

AVK AIR RELEASE VALVES S851



EXPECT  
QUALITY YOU  
CAN RELY ON

Expect... **AVR**

# SERIES 851 AIR RELEASE VALVE FOR WATER AND SEWER APPLICATIONS



## Air Release Valves for Water Pipeline Systems

Why have them at all? What types are available? What are their respective function? How many are required? What size should they be? Where should they be installed? What air flow will they give?

These are some of the questions which are posed by Engineers and Water Authorities when confronted with the subject of air valves.

**The consequences of air in a pipeline system are not always fully appreciated. Consider, for example, a typical pipeline of any diameter, one kilometre in length that has been filled with water and released of air.**

In most cases this pipeline would still contain enough dissolved air to completely fill over 20 metres length of the pipe, because water, at standard conditions, contains at least 2% dissolved air by volume.

The presence of air in a pipeline which is in the process of either being charged or actually in service can cause delay in filling, throttling, and hence reduction in discharge capacity, a higher risk of water hammer and surges, increased corrosion of the inner pipe surfaces and reduce pump efficiencies leading to increased energy

costs.

The effective removal of air provides many benefits, such as increased pumping efficiency, reduced vibration and corrosion, all combining to give an important saving in energy consumption.

If maximum efficiency is to be obtained from a system, it is essential that the line be primed quickly, all the air removed and the fluid permitted to run full.

In order to attain this, it is necessary to adequately ventilate the pipeline by some means, since the ideal of having a uniform, upward gradient, in the direction of flow, free from all obstructions is not normally possible, due to such natural hazards as hills, valleys, bridges, rivers etc.

The simplest and most effective device for the purpose of ventilation is the vent pipe or

vent stack. This, however, is not a practical proposition in the majority of installations, hence air valves are designed to fulfil this duty. Suitability designed air valves are thus automatically able to permit - in required quantities - the release of air from, and the introduction of air to the particular pipeline involved. They should also close and remain drop tight under a minimum of positive pipeline pressure and open whenever pipeline depression occurs.

We believe that 'size for size' the Glenfield designed AVK Series 851 will give better inflow pipe protection rates and higher outflow rates for increased pump efficiencies than any other valve available in the Chinese market.

**“PUT US TO THE TEST”**

**“Better flow = better system efficiencies”**

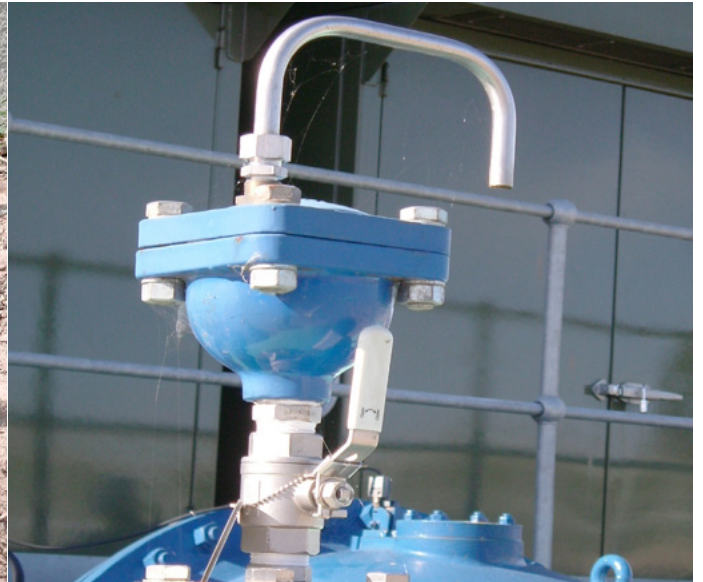

## Air Release Valves designed for the purpose...

There are two basic air release valve types which are commonly referred to as single small orifice and double orifice air valves. These are illustrated in the following figures respectively.

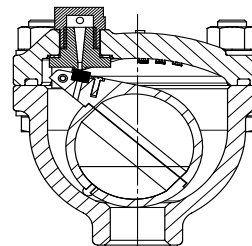

### AVK Series 851/00 Single Small Orifice Air Release Valves

The small Orifice valve is designed to open and allow the escape of air which has accumulated in the system during the pressurised working conditions.

When air has collected in the valve body, it depresses the water level until a point is reached where the buoyancy is reduced such that the opening force created by the weight of the float is greater than the closing force generated by the system pressure operating on the unbalanced area of the Orifice.

With the AVK Series 851 Air Release Valve illustrated, the Orifice size ranges from 3.5mm (PN6) to 1.75mm (PN25) diameter giving optimum performance on varying working pressures from 6 to 25 bar respectively.

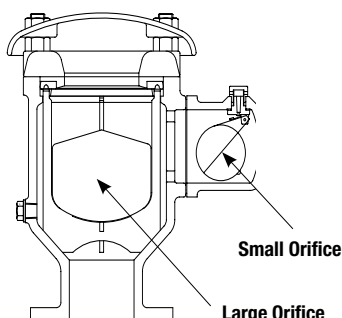

### AVK Series 851/10 & 851/20 Double Orifice Air Release Valves

In most pipeline systems, the ventilation requirements are such as to warrant the use of both small and large Orifice air valves at the same point.

Hence, it is usual to install a valve of the Double Orifice Air Release Valve type Series 851, which incorporates both of these valve functions in a single unit. The performance of such a valve is namely ventilating the pipeline during filling and emptying sequences together with the ability to release air under pressure working conditions. It also embodies the unique Glenfield designed Aerokinetic Principle which has been incorporated in this valve since 1970.

The purpose of this valve is to permit large volumes of air to exhaust during initial filling of a pipeline and also allow air to enter the pipeline in sufficient quantities during emptying. This air inflow rate must be adequate to enable pipeline dewatering or scouring to be conducted

quickly and without endangering the pipeline to high vacuum pressures. It remains in the open position during filling until buoyed on to its rubber seat (EPDM) by the arrival of the water.

In the large Orifice float design it is most important so that the float is not prematurely blown or forced shut. This was a problem experienced in the older rubber covered ball type valves. This difficulty has now been overcome by the 'Glenfield Aerokinetic' feature which will not allow the valve to blow shut while discharging air at any pressure or discharge rate. Essentially, this feature gives a resultant pressure on the float which acts in a downward direction and increases in magnitude as the emergent air velocity increases.

Thus, for a similar sized inlet, the Aerokinetic valve has a much higher discharge capacity than other valve designs. This enables in most instances, the use of an air valve one size smaller than was previously possible, for a given discharge rate with a cost effective outcome.

# OPERATION THE AEROKINETIC PRINCIPLE



AVK's Large Orifice Series 851 Air Release Valves incorporate the exclusive Glenfield Aerokinetic Principle which prevents premature closure while air is being released from a pipeline.

**The valve only closes when water reaches and lifts the float into contact with the seal.**

It cannot be prematurely shut by discharging air or a mixture of air and water spray irrespective of emitting velocity. The valve float and the valve internal body profiles are specially shaped, and the positioning of the float relative to

the valve inlet is critical. Thus, when air is discharging the resultant direction of aerodynamic forces is downward on the float which increases as the emergent air velocity increases.



## AERODYNAMIC FORCES

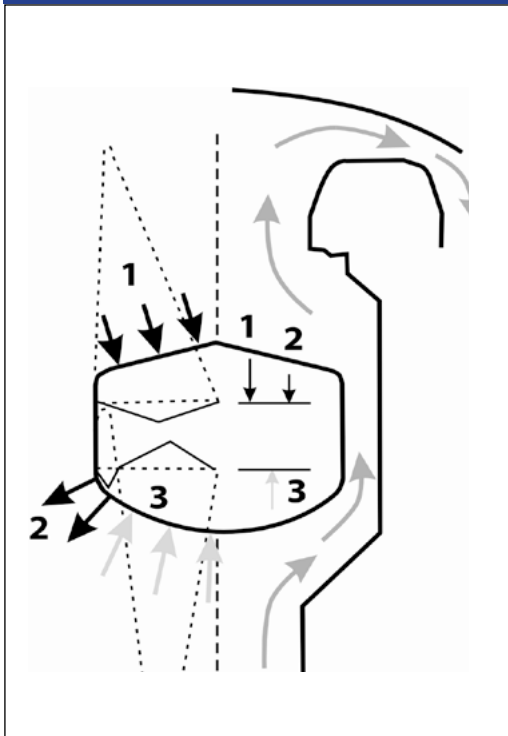

## CAPTURING EFFICIENCIES

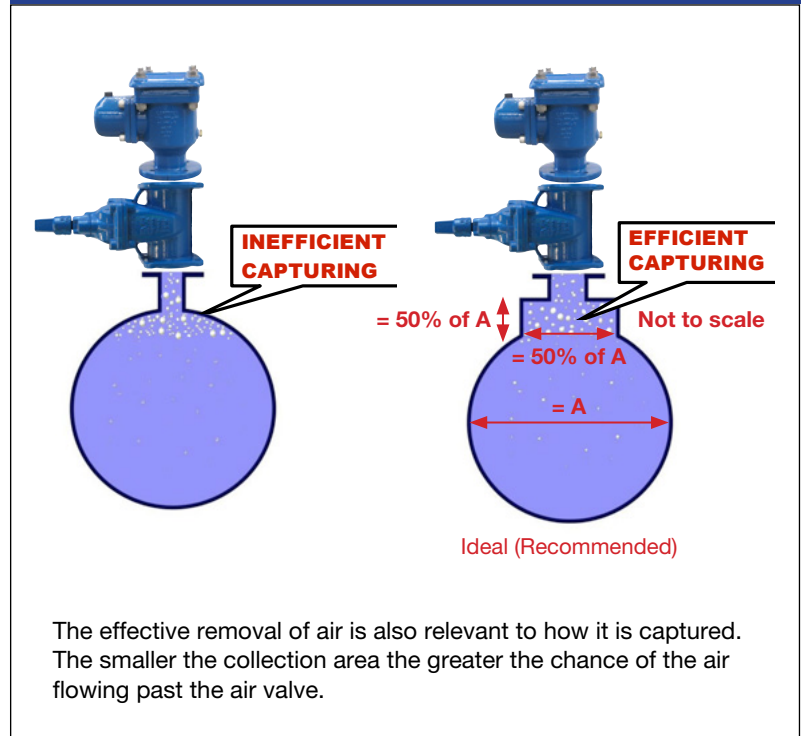

The end result is, if the valve is sized correctly and capture area is maximised, efficiencies will be improved. Below is a graph showing pump run time before and after the installation of the AVK Series 851/50 Air Release Valve.

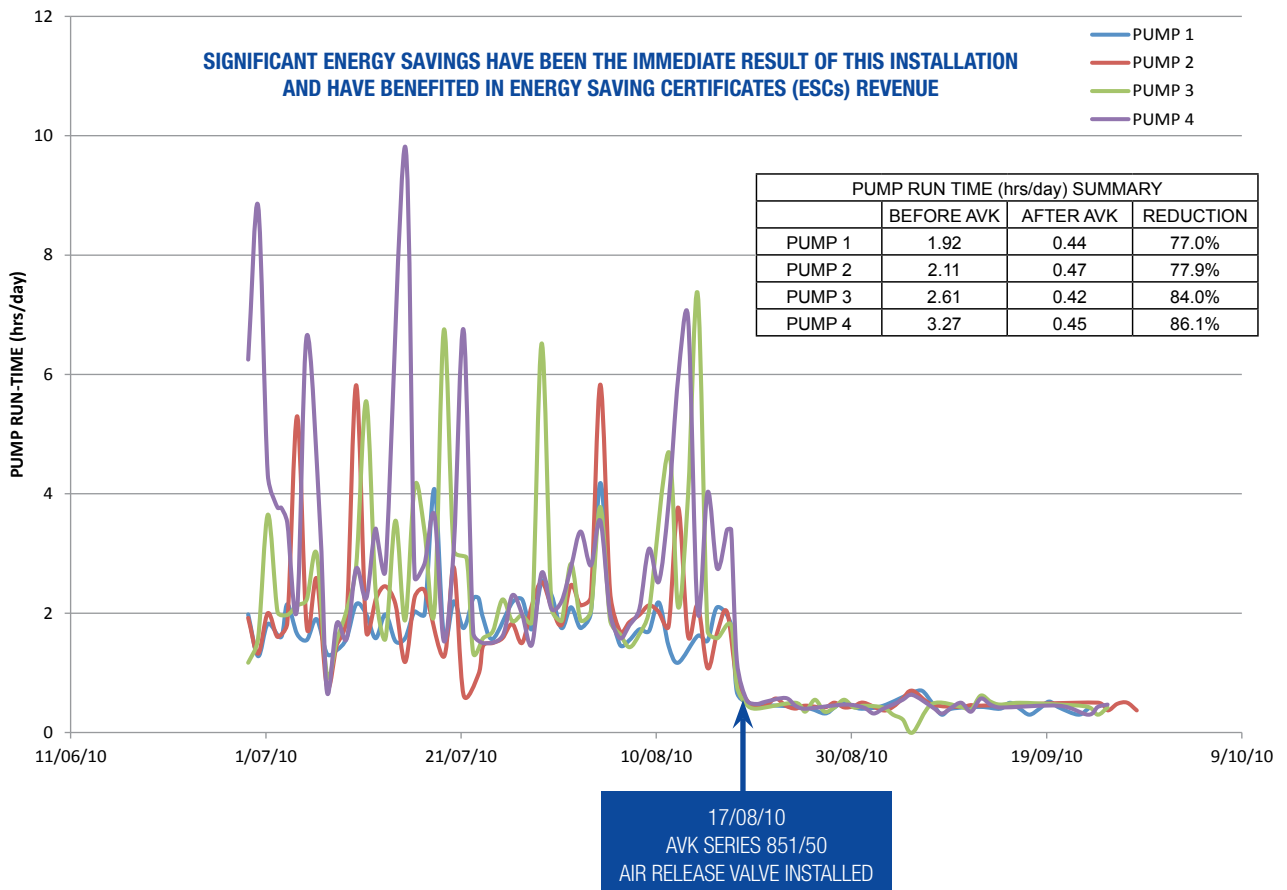

# AIR VALVE SELECTION GUIDES

## 01 Large Orifice Valves Full Curves For Series 850/10 & 851/20



### LARGE ORIFICE VALVES Full curves for Series 851/10 & 851/20

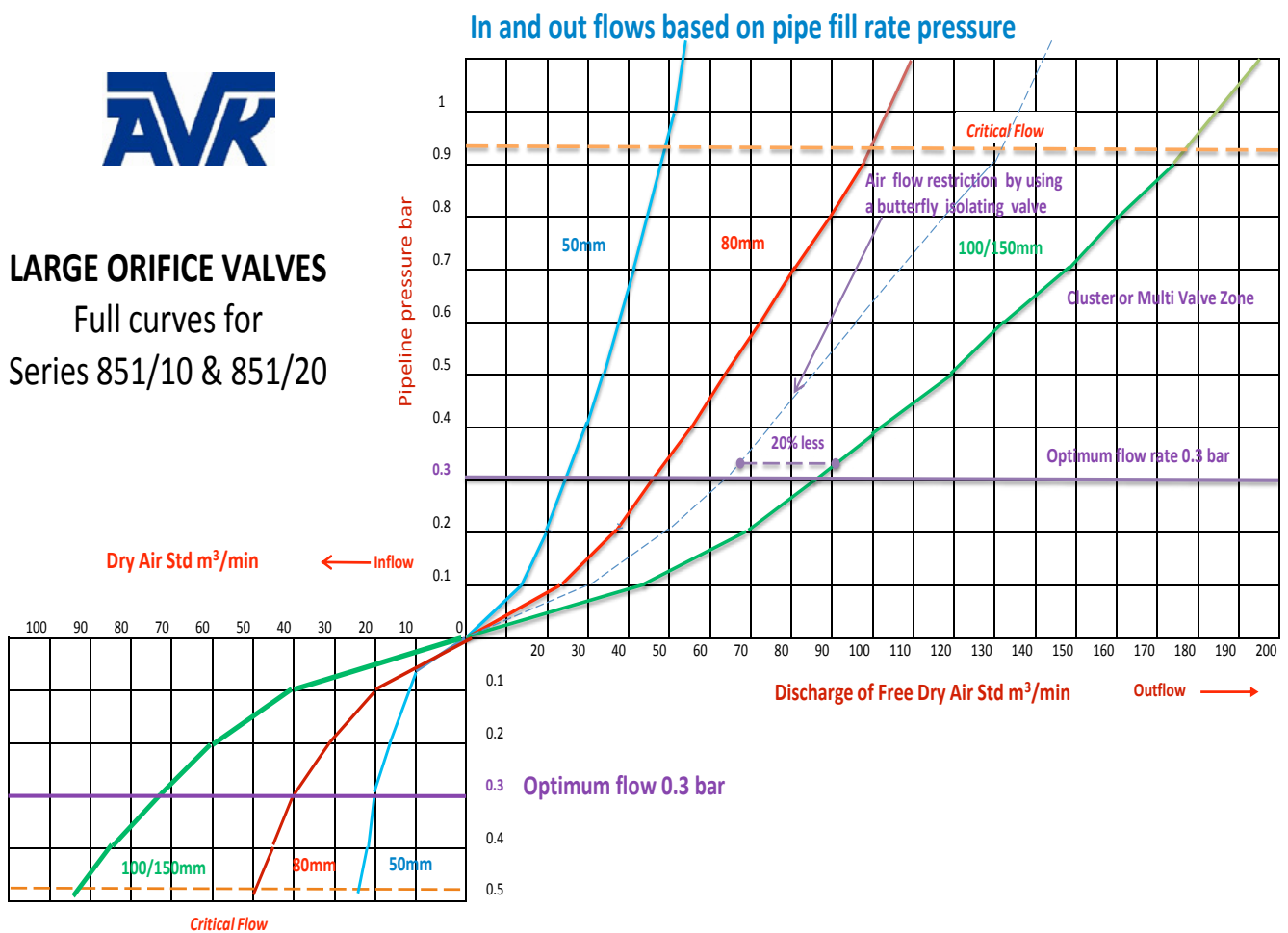

### THREE WAY VALVE SIZE SELECTIONS

- By known inflow rate - use Graph 1.
- By pipe size - use Graph 2.
- By flow rate - use Graphs 2 and 3.

Selection example: 600mm pipe with a design flow of approximately 2m/s...  
What size air valve do you select?

1. Graph 2 suggests an 80mm valve would be suitable, for example it's in the 80mm zone.
2. Graph 3 shows a flow rate of 33.91m<sup>3</sup>/min.
3. To check size selection the inflow on Graph 1 should equal or better this flow rate.
4. Therefore at 0.3bar inflow an 80mm valve will allow 40m<sup>3</sup>/min in and would be the correct selection.

## 02 General Air Valve Sizing

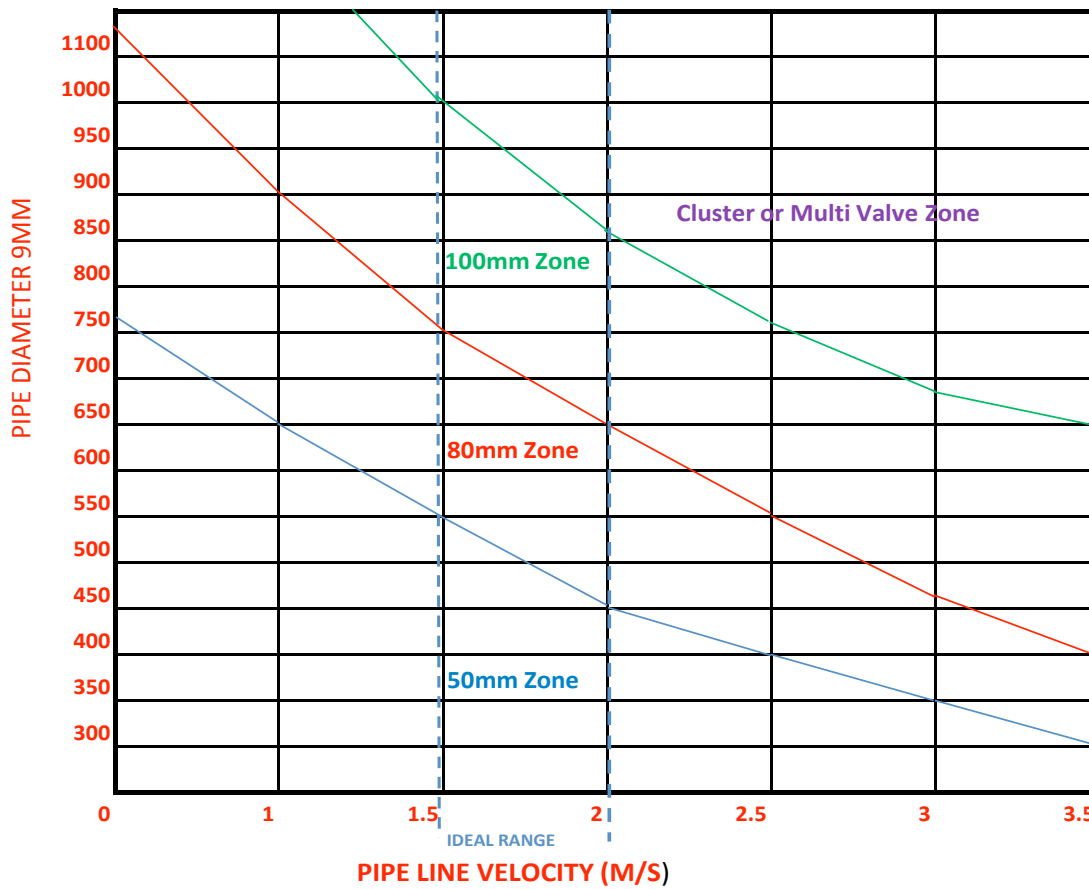

## 03 Flow Rate Valve Sizing

FLOW RATES THROUGH PIPES IN M<sup>3</sup>/min

Pipe Size	Flow rate in metres per sec					
	1	1.5	2	2.5	3	3.5
300	4.26	6.36	8.46	10.62	12.72	14.82
350	5.76	8.64	11.52	14.46	17.34	20.22
400	7.56	11.28	15.06	18.84	22.62	26.42
450	9.54	14.34	19.08	23.88	28.62	33.42
500	11.76	17.75	23.58	29.46	35.34	41.22
550	14.52	21.75	28.62	36.54	43.15	50.21
600	16.98	25.44	33.91	42.42	50.88	59.42
650	20.15	29.53	40.41	50.24	60.38	70.12
700	23.11	34.62	46.25	57.72	69.32	80.82
750	26.52	39.78	53.04	66.24	79.55	92.76
800	30.18	45.24	60.35	75.42	90.48	105.48
850	34.02	51.06	68.11	85.14	102.12	119.16
900	38.16	57.24	76.32	95.42	114.54	133.62
950	42.54	63.78	85.14	106.32	127.56	148.86
1000	47.12	70.68	94.26	117.78	141.36	164.94
1200	67.86	101.76	135.72	169.62	203.58	237.48

"Flow is more important than flange size"

# FEATURES & BENEFITS



## Series 851 Air Release Valves

Feature	Benefit
High air flow capability	Can use a smaller valve and isolator
Aerokinetic design float allows higher air flow rates and will not blow shut. Critical flow 0.9bar	Higher flow through smaller valve. Others are limited to 0.3bar
Aerokinetic design float prevents the chance of float closing via air surges or higher velocities	Increases the speed of filling and prevents the chances of water hammer damage or noise
Seat design allows sealing at pressures as low as 0.1bar	Seals in low flow, low pressure applications
Valve internals can be replaced easily and safely	No need to introduce water to float pistons to the surface of the chamber
Seals can be checked or tested without removing the covers	Valve operation can be checked quickly by one person

## Series 851 Sewage Air Release Valves



Feature	Benefit
Aerokinetic Principle	Will not blow shut
Cylindrical Float	Will not roll shut
ABS plastic Guides	No damage to internal coating
Full Bore Outlet	Maximum airflow capacity
Low sealing pressure	Optimum for low hydraulic gradients
Proven design	Reliability
Temp range – 10 to + 70°C	Wide range of application
Accessories	Flexibility
Vented non return valve	Surge alleviation
In flow check valve	Can be used with negative hydraulic gradient
Piped outlet connection	Enables use with nauseous gases
High quality materials & FBE coating to AS 4158	Longevity
Boyles law complaint	Working parts totally clear of medium
Liberal body contours	Clogging free operation
Large clearance around float	No blockages







## When should you use anti slam units on air release valves?

A wise man once said...

“If a pipeline is properly de-aerated you can’t guarantee against a line break. However, if you don’t properly de-aerate the pipeline you should be prepared for one”.

**The problems caused by air in pipelines are well documented and include but are not limited to:**

- **Reduced pump efficiencies**
- **Increased energy costs**
- **Noise and vibration**
- **Lower flow rates**
- **Problems with PRV’s and other flow control equipment**
- **Surges and water hammer problems**
- **Increased corrosion potential**

Because of these problems air should be removed from pipelines as quickly as possible when filling or recharging the main after maintenance. This is also equally true for allowing air into the system should there be a conduit break.

One occasion where the above does not hold true however, is where the possibility of water hammer can occur as two columns of water

meet at the air release valve. At this point the release of the air should be slowed; this can be accomplished by use of an anti-slam device. Therefore it is recommended that where the air release valve is situated above the hydraulic gradient, or if the valve is positioned such that the returning filling flow will come from both directions an anti-slam device should be considered.

**It should be noted however that if these devices are used on all air release valves there is a high risk in reducing the effectiveness of the de-aeration system, as anti slam devices by nature slows the outflow of air. Do you need this on every valve?**

It should also be ensured that when fitting (or retro-fitting) anti-slam devices, that the device is not being fitted because the air release valve does not have enough capacity in the first

place. The fitting of the anti slam device may resolve the issue of the valve slamming shut due to the incapacity of the valve to handle the volume. However this would only increase the ineffectiveness of an incorrectly sized air release valve to carry out its original function. Which is, to remove the air from the pipeline effectively!

When reviewing the air release valve requirements for a specific pipeline particular attention should be given to not only the number, size and location of the air release valve but also where anti slam devices may be needed.

In these situations retrofit fitting is available to assist in the alleviation of surges in the pipeline. This unit is fitted in place of the normal cover and cowl. This can be fitted on site or as part of complete unit.

## Anti Slam Unit

**In situations where pipeline profile can lead to water column separation on a pump trip, high shock pressures can be generated when the separated column rejoins.**

The air valve combined with an anti-slam unit valve allows air to enter (C) the pipeline freely by lifting disc (A) on separation, but controls the expulsion of air via an adjustable 4mm needle (B) (that can be “tuned” on site after installation) valve unit, as the water column rejoins and disc (A) closes. This has the effect of creating an air buffer between the water column interfaces, reducing the impact velocity of the rejoining column water and the surge potential of the system.

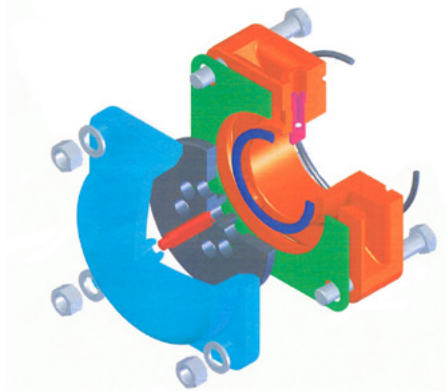
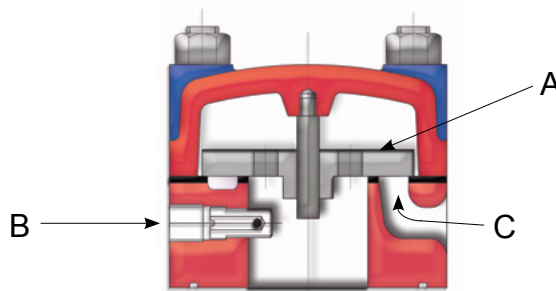

# AVK AIR RELEASE VALVES



## Series 851/00

Single threaded  
Single small orifice  
Resilient seated  
Standard option  
DN25  
PN16  
Ductile iron

Options:

- SS316 float
- SS316 float fuides
- LG2 orifice cover/bracket

Datasheets:  
• 851/00-001



## Series 851/10

Single flanged  
Double orifices  
Resilient seated  
Standard option  
DN50-150  
PN25  
Ductile iron

Options:

- SS316 float
- SS316 float fuides
- LG2 orifice cover/bracket

Datasheets:  
• 851/10-001



## Series 851/10

Single flanged  
Double orifices  
Resilient seated  
Vented non-return  
DN50-150  
PN25  
Ductile iron

Options:

- SS316 float
- SS316 float fuides
- LG2 orifice cover/bracket

Datasheets:  
• 851/10-002



## Series 851/10

Single flanged  
Double orifices  
Resilient seated  
In-flow check  
DN50-150  
PN25  
Ductile iron

Options:

- SS316 float
- SS316 float fuides
- LG2 orifice cover/bracket

Datasheets:  
• 851/10-003



## Series 851/10

Single flanged  
Double orifices  
Resilient seated  
Piped outlet  
DN50-150  
PN25  
Ductile iron

Options:

- SS316 float
- SS316 float fuides
- LG2 orifice cover/bracket

Datasheets:  
• 851/10-005



## Series 851/20

Single threaded  
Single large orifice  
Resilient seated  
Standard option  
DN25  
PN10/16  
Ductile iron

Options:

- SS316 float
- SS316 float fuides

Datasheets:  
• 851/20-005



## Series 851/20

Single flanged  
Double orifices  
Resilient seated  
Standard option  
DN50-200  
PN10/16  
Ductile iron

Options:

- SS316 float
- SS316 float fuides
- LG2 orifice cover/bracket

Datasheets:  
• 851/20-003



## Series 851/20

Single flanged  
Double orifices  
Resilient seated  
Vented non-return  
DN50-150  
PN10/16  
Ductile iron

Options:

- SS316 float
- SS316 float fuides
- LG2 orifice cover/bracket

Datasheets:  
• 851/20-004



## Series 851/20

Single flanged  
Double orifices  
Resilient seated  
In-flow check  
DN50-150  
PN10/16  
Ductile iron

Options:

- SS316 float
- SS316 float fuides
- LG2 orifice cover/bracket

Datasheets:  
• 851/20-012



**Series 851/20**

Single flanged  
Double orifices  
Resilient seated  
Piped outlet  
DN50-150  
PN10/16  
Ductile iron

- Options:
- SS316 float
  - SS316 float fuides
  - LG2 orifice cover/bracket

Datasheets:  
• 851/20-013



**Series 851/20**

Single flanged  
Double orifices  
Resilient seated  
Standard + Cluster  
DN150-250  
PN10/16  
Ductile iron

- Options:
- SS316 float
  - SS316 float fuides
  - LG2 orifice cover/bracket

Datasheets:  
• 851/20-006



**Series 851/20**

Single flanged  
Double orifices  
Resilient seated  
VNR + Cluster  
DN150-250  
PN10/16  
Ductile iron

- Options:
- SS316 float
  - SS316 float fuides
  - LG2 orifice cover/bracket

Datasheets:  
• 851/20-007



**Series 851/40**

Single flanged  
Double orifices  
Resilient seated  
Standard option  
DN50-200  
PN10/16  
Ductile iron

- Options:
- SS316 float
  - SS316 float fuides
  - LG2 orifice cover/bracket

Datasheets:  
• 851/40-001



**Series 851/40**

Single threaded  
Double orifices  
Resilient seated  
Standard option  
DN25  
PN10/16  
Ductile iron

- Options:
- SS316 float
  - LG2 orifice cover/bracket

Datasheets:  
• 851/40-002



**Series 851/50**

Single flanged  
Sewage application  
Double orifices  
Resilient seated  
Standard option  
DN80  
PN10/16  
Ductile iron

- Options:
- Piped outlet

Datasheets:  
• 851/50-001

Note: Datasheets only show part of variants. More variants are available, please contact AVK if required.



**AVK VALVES MANUFACTURING MALAYSIA SDN BHD** (446267-K)

Lot No. 1, Jalan Sg. Chadong 8,  
Batu 5 ½ Miles, Jalan Kapar,  
42100 Klang,  
Selangor Darul Ehsan.

Tel : +603 3291 8270

Fax : +603 3291 7067

Email : [customer.care@avkvalves.com.my](mailto:customer.care@avkvalves.com.my)

Website : <https://www.avkvalves.com>

Expect... **AVK**